

TIRA

30 E6 HH 40

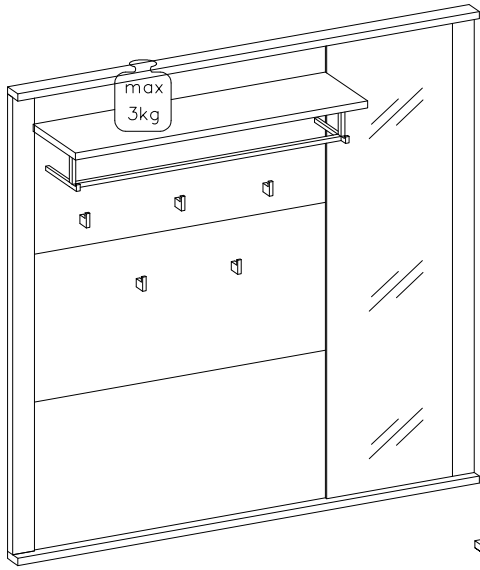

#	ART. NR	L	W	T	Q	Col.No
1	8011	845	446	16	1	1
2	8012	845	446	16	1	1
3	8013	845	446	16	1	1
4	8014	1338	375	16	1	1
5	8015	1338	64	22	2	1
6	8016	1350	27	22	2	1
7	8017	1336	373	22	1	1

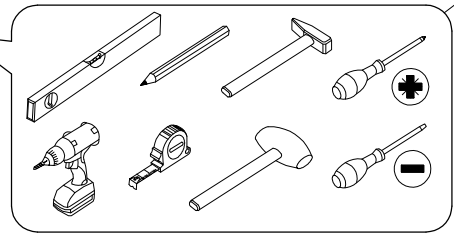
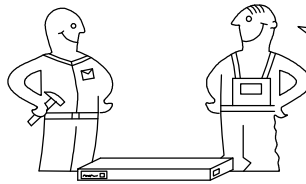
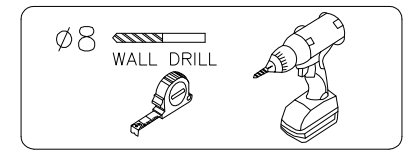
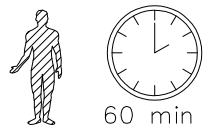
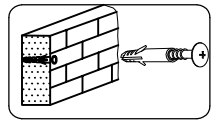
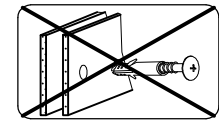
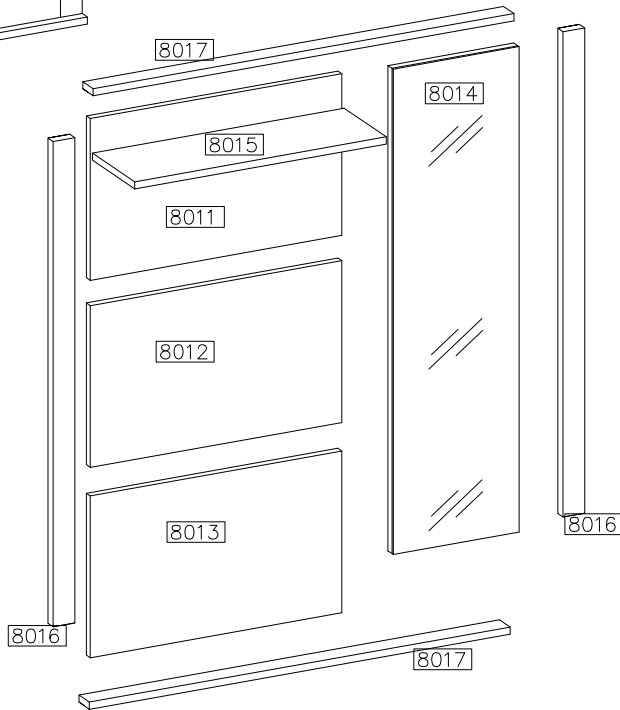
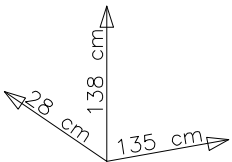
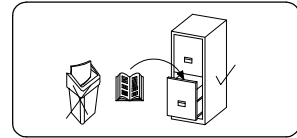
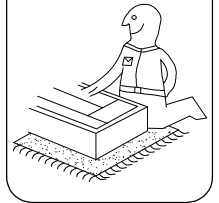
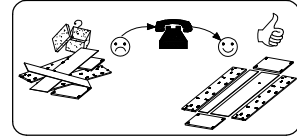
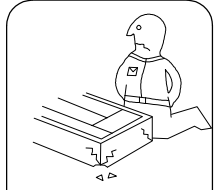
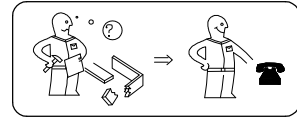

Ø8x30mm A	Ø8x40mm A1	7x50mm B		Ø15/12mm C					
8	18	5	3	42	20	11	42	5	1
5.0x9mm P8	M4.0x22mm R2	M4.0x35mm R3			Ø8.0x50mm Z1				
6	12	2	1	5	4				

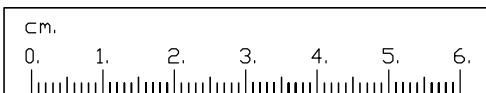

1

∅15/12mm



28

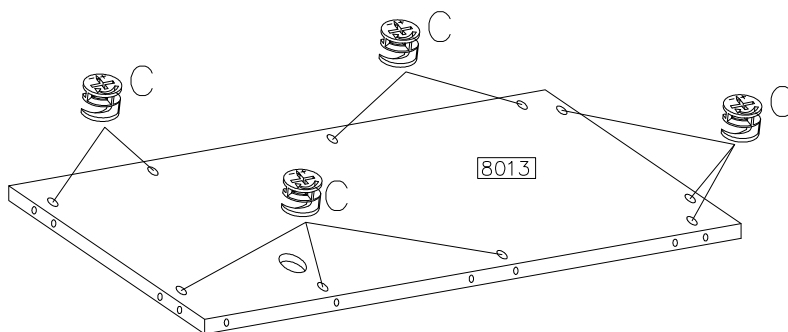
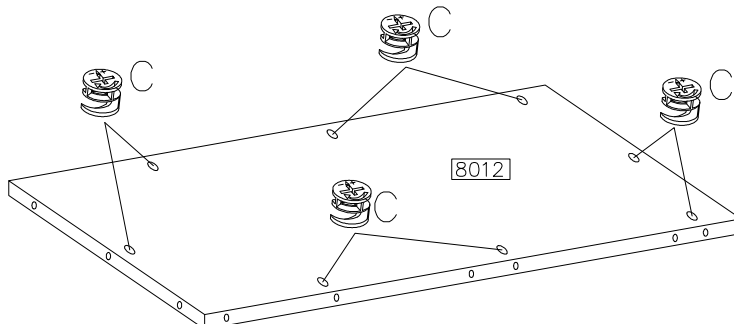
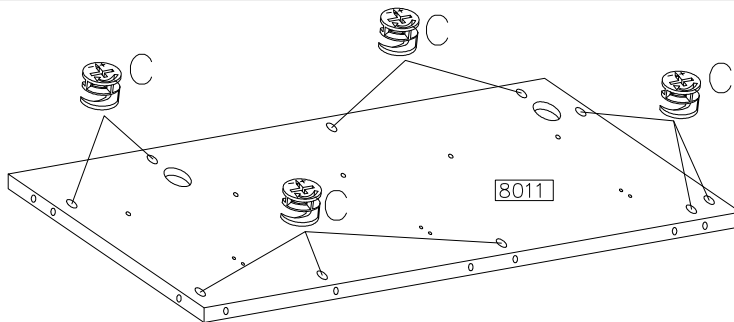
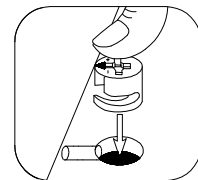

2

∅15/12mm



14

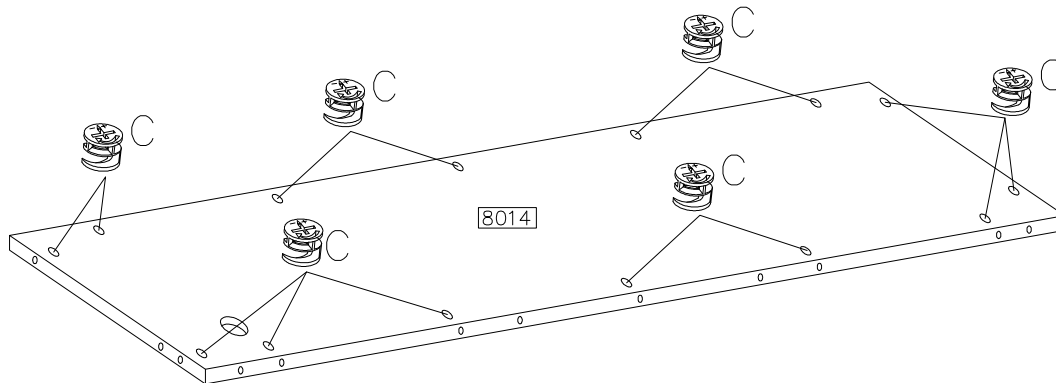
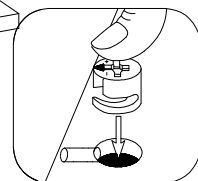

3

2x



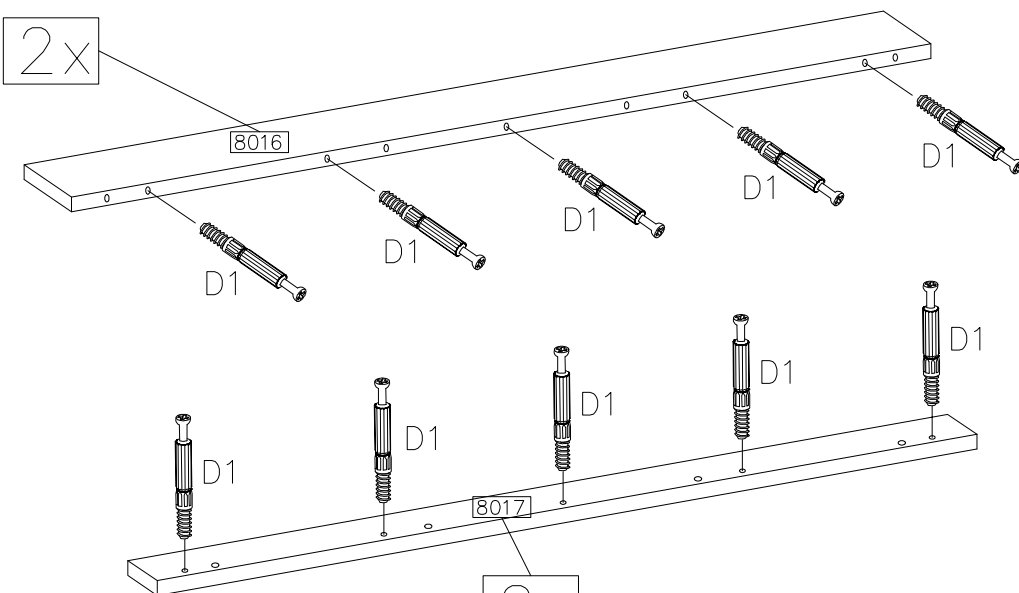
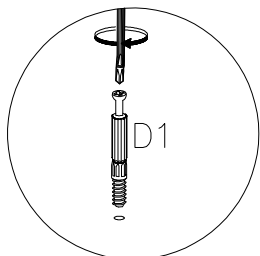

20





2x

4

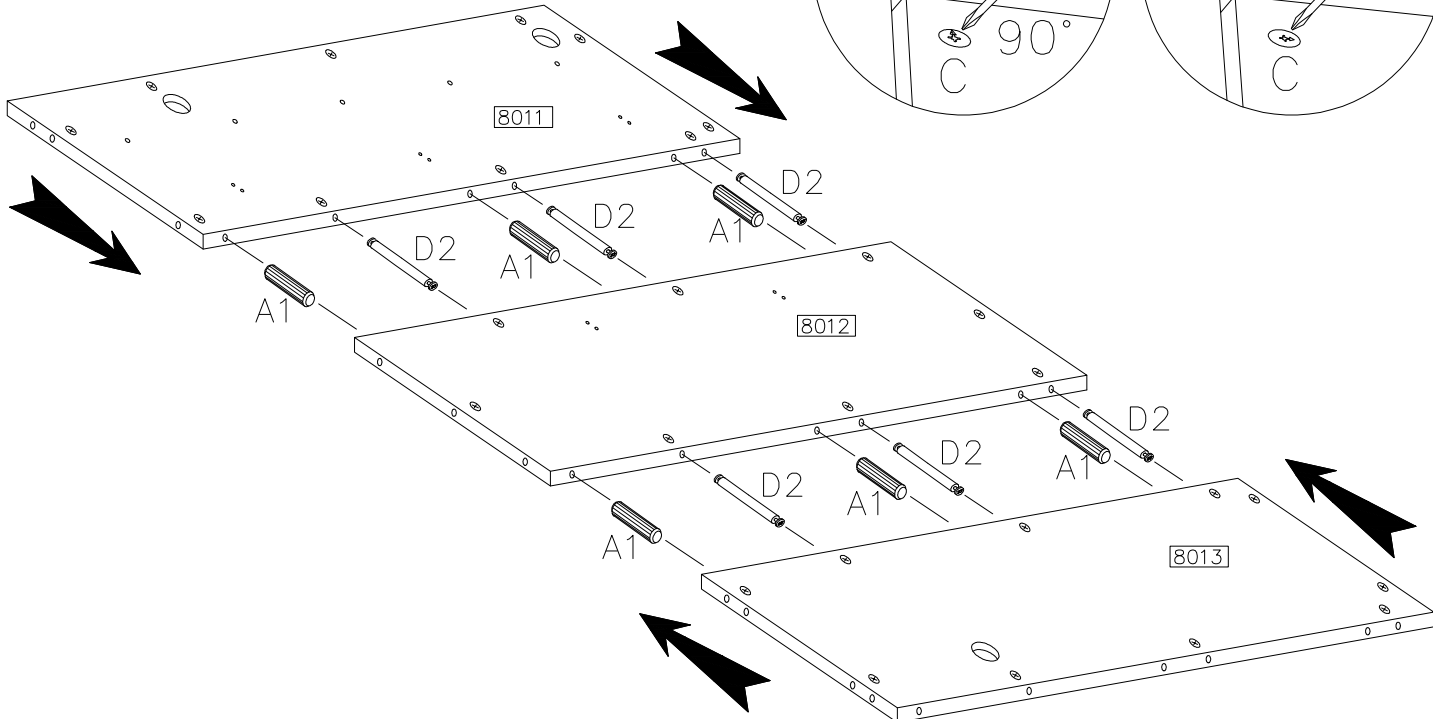
 A1 6	 D2 6
---	---



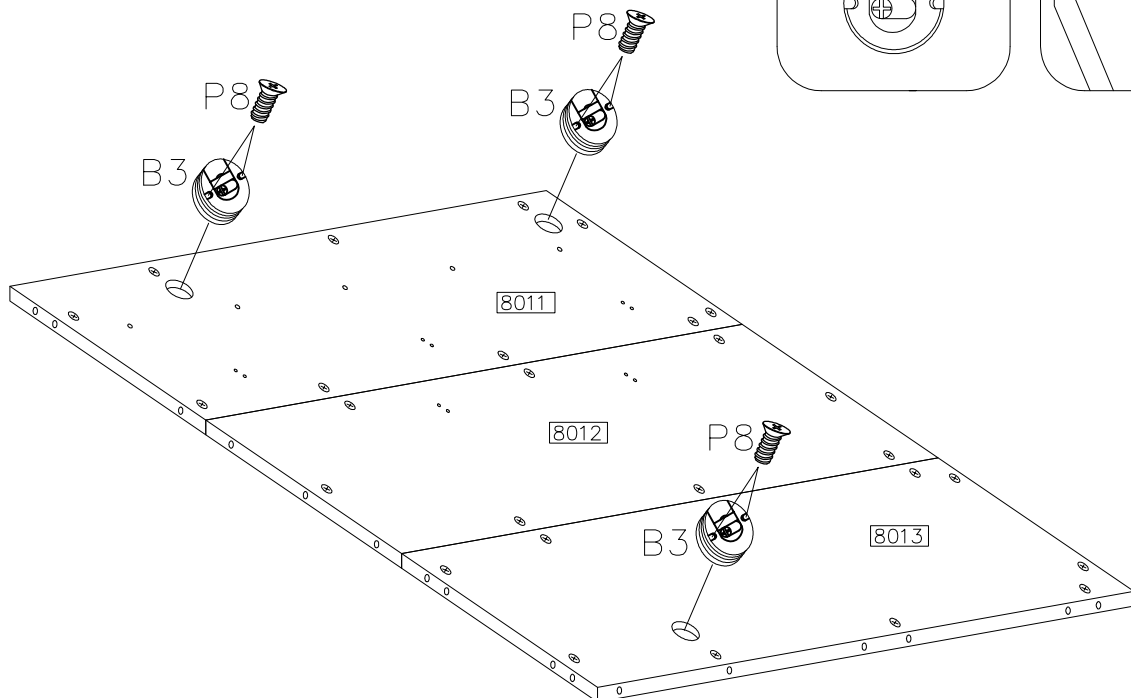
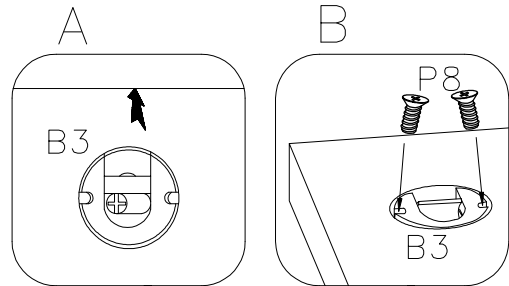

5

 B3 3	 P8 6
--	--



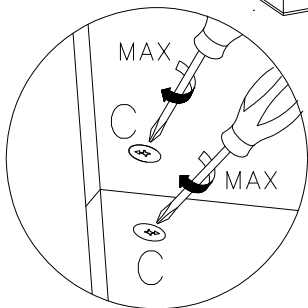
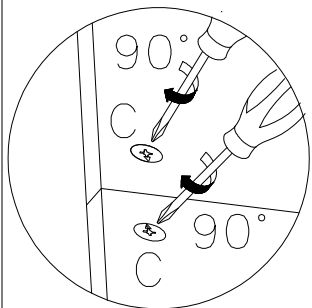
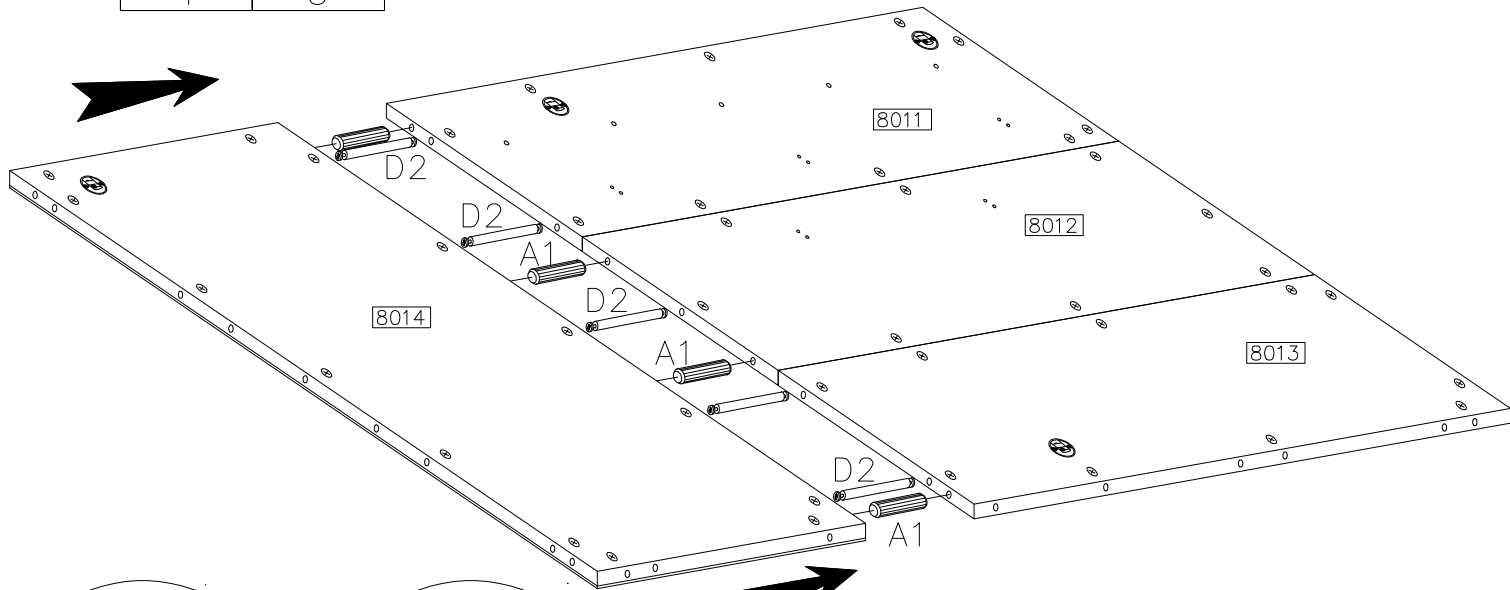

6

ø8x40mm	
	
A1	D2
4	5



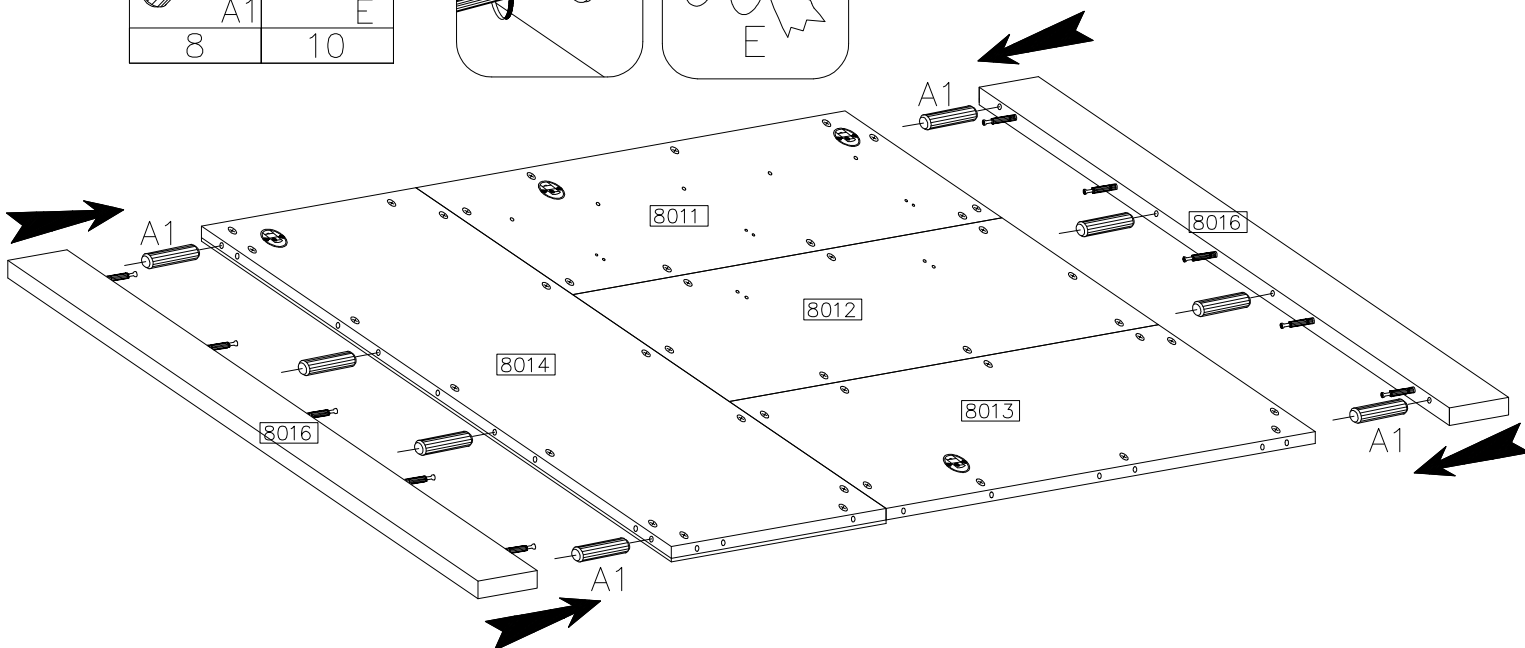
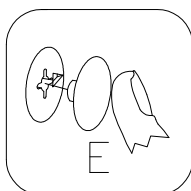
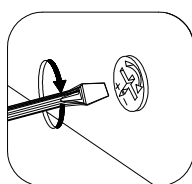

7

ø8x40mm	
	
A1	E
8	10



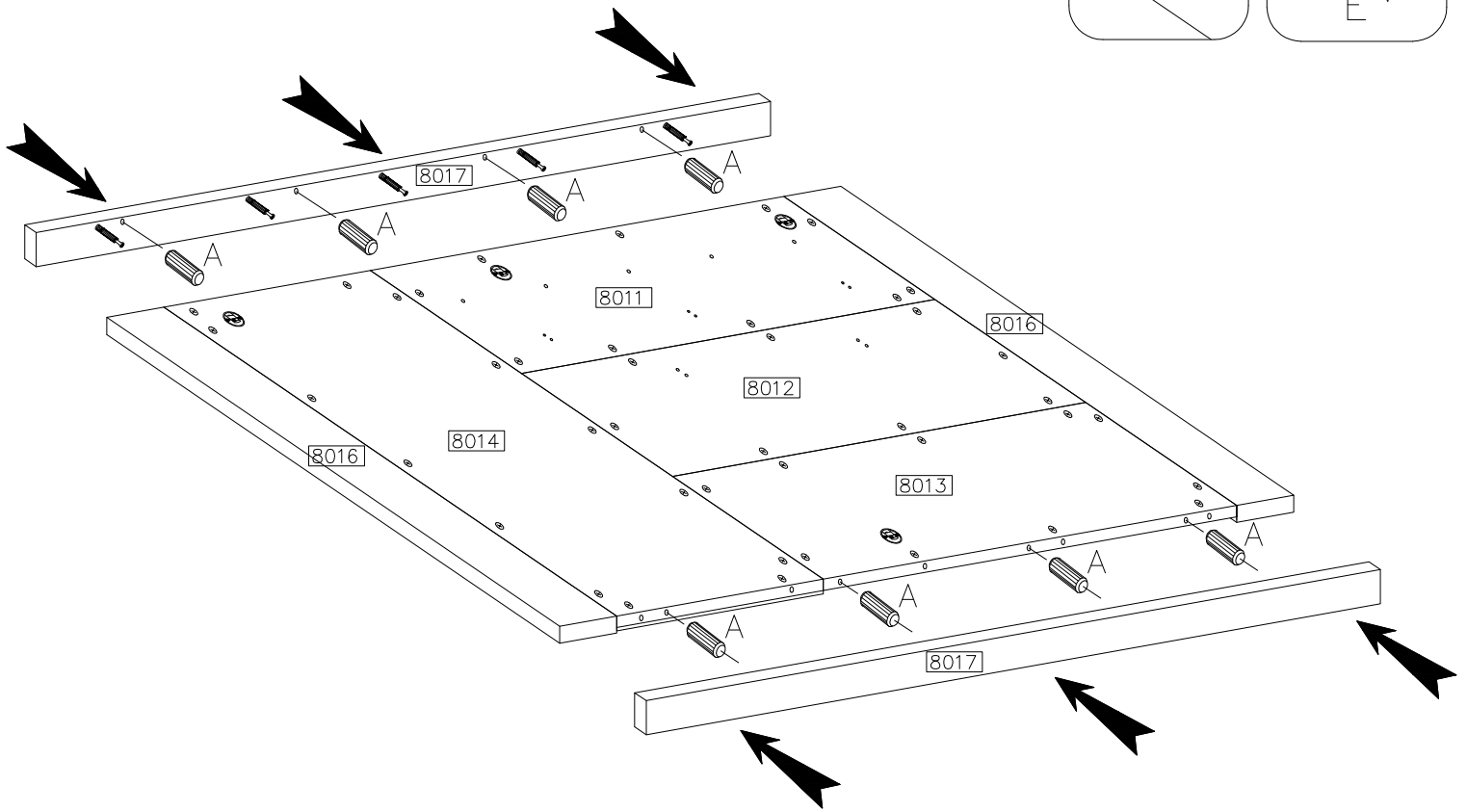
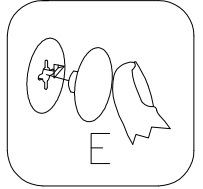
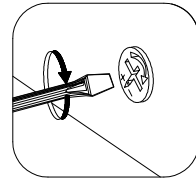

8

 A	 E
8	10





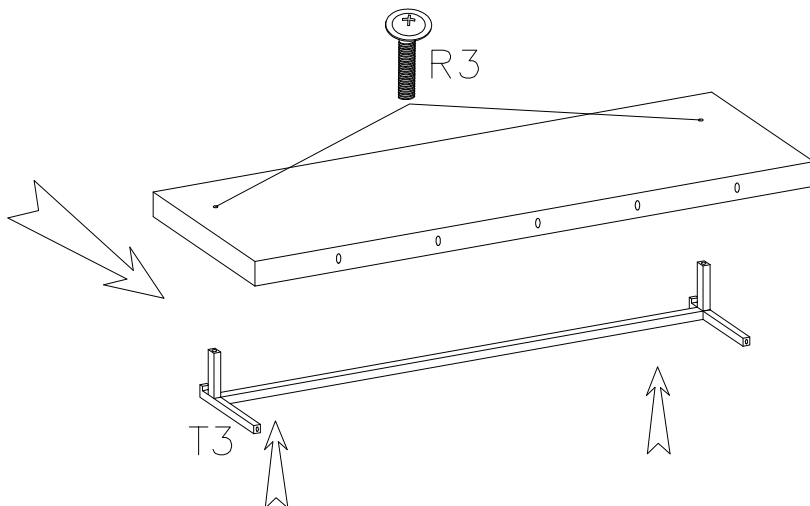
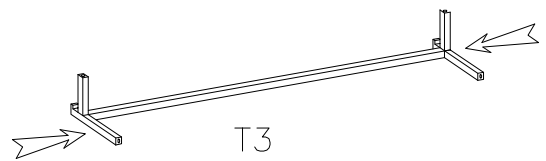

9

 T3	 R3
1	2



10

7x50mm  B	 O
5	1
M4.0x22mm  R2	 T4
12	5

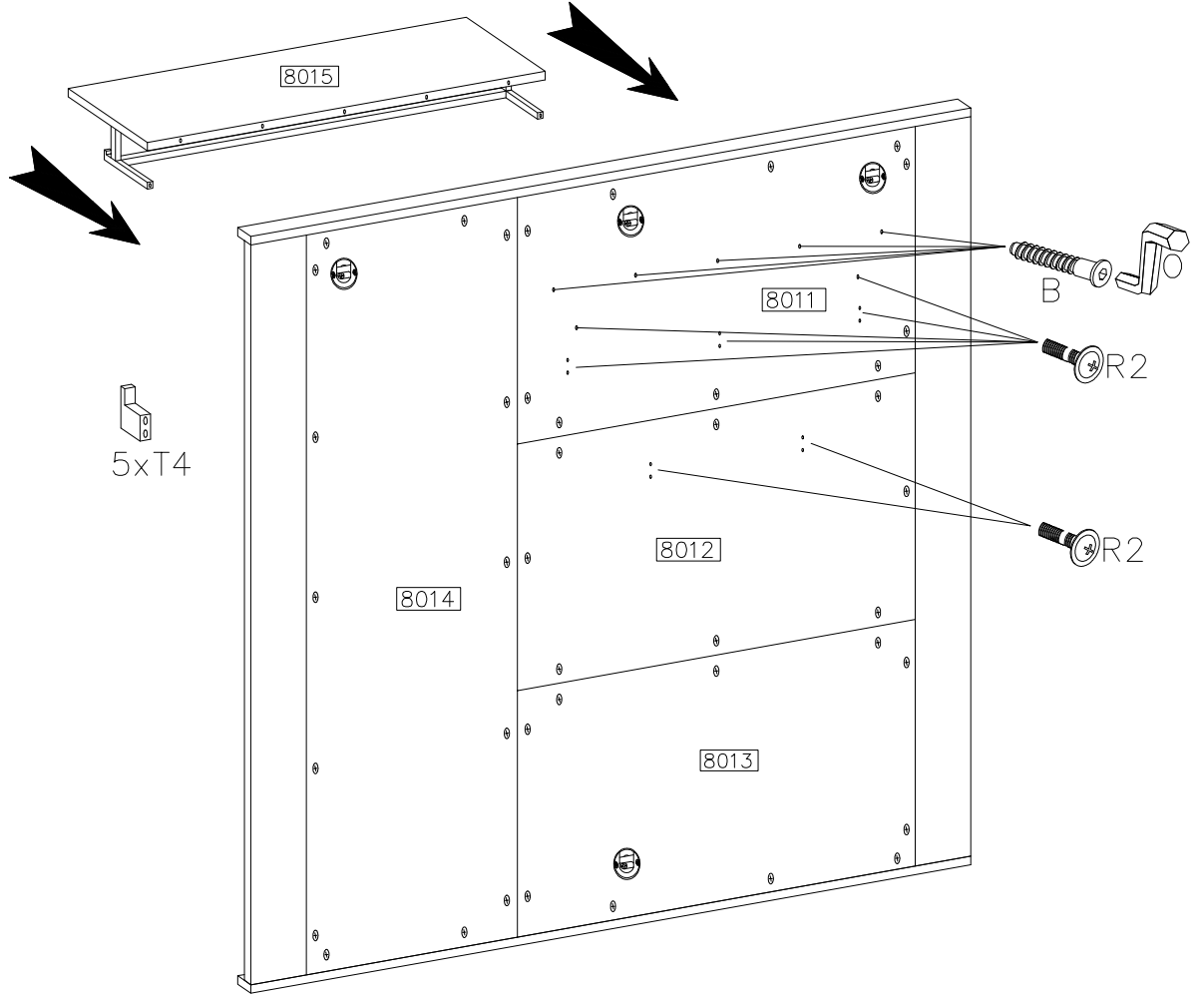

11

ø8.0x50mm  Z1
4

