

STEP ST 4

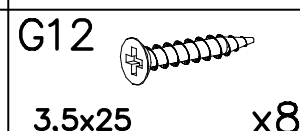

I

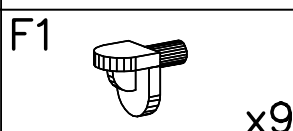
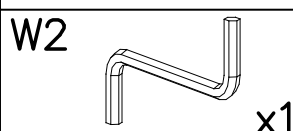
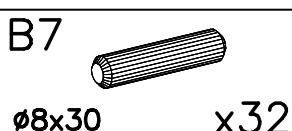
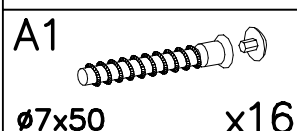
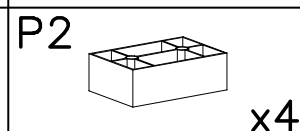
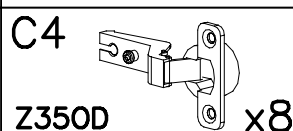
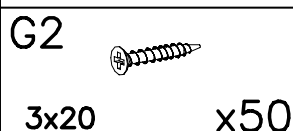
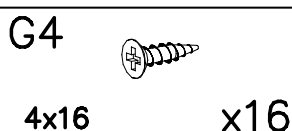
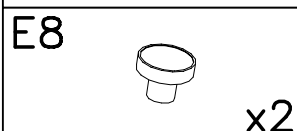
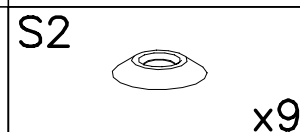
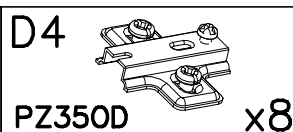
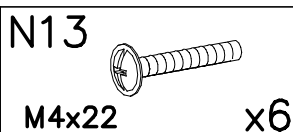
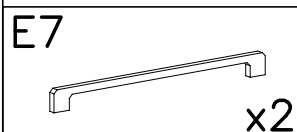
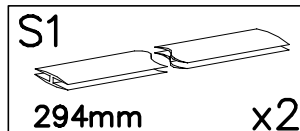
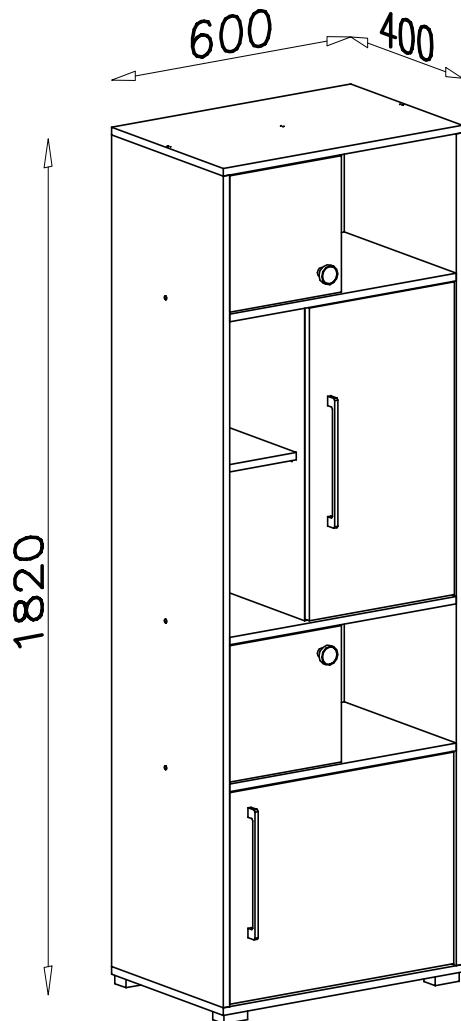
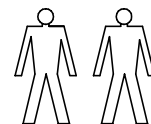
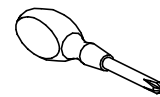
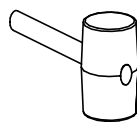
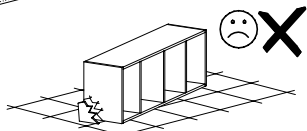
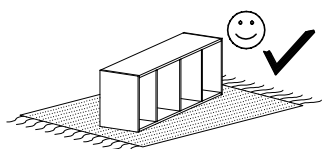
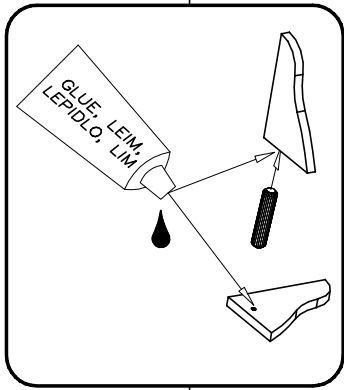

II

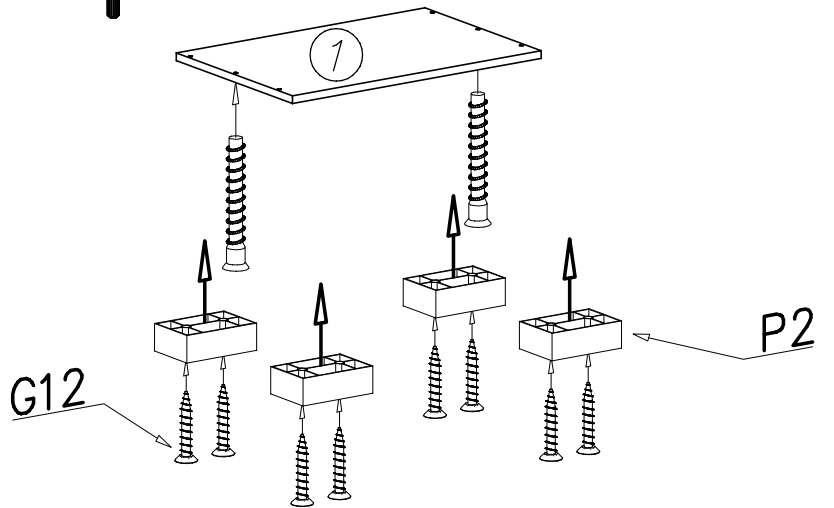
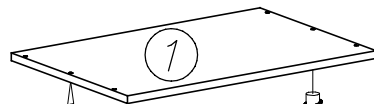
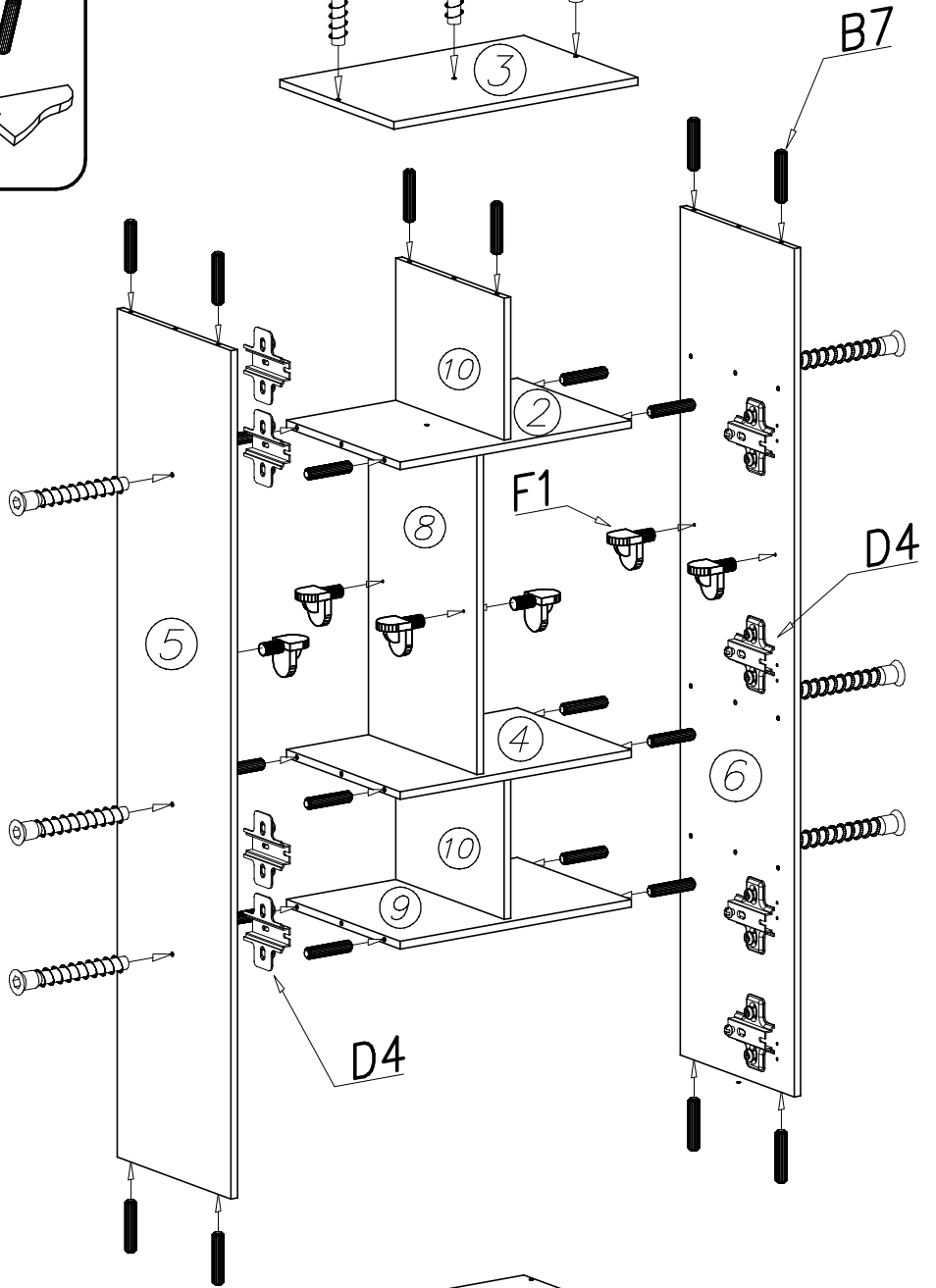
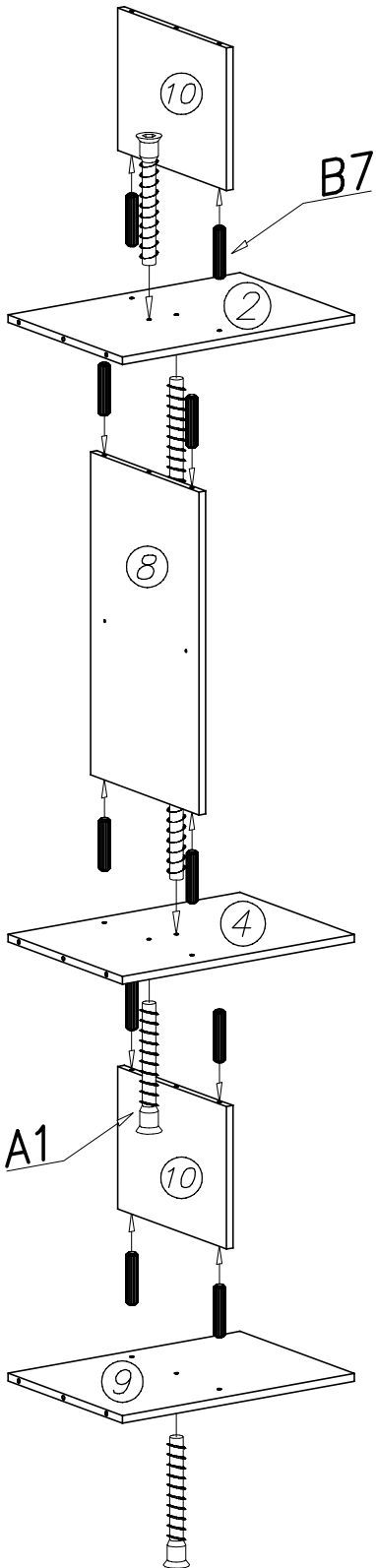
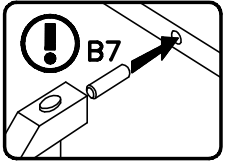
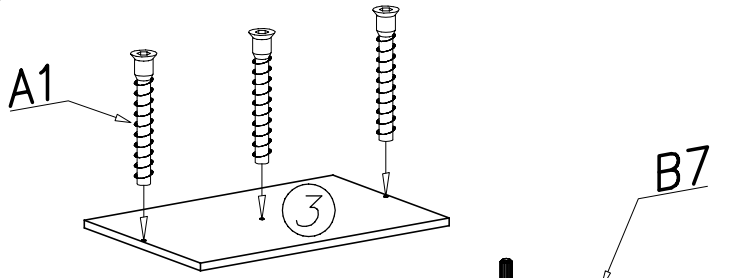

III

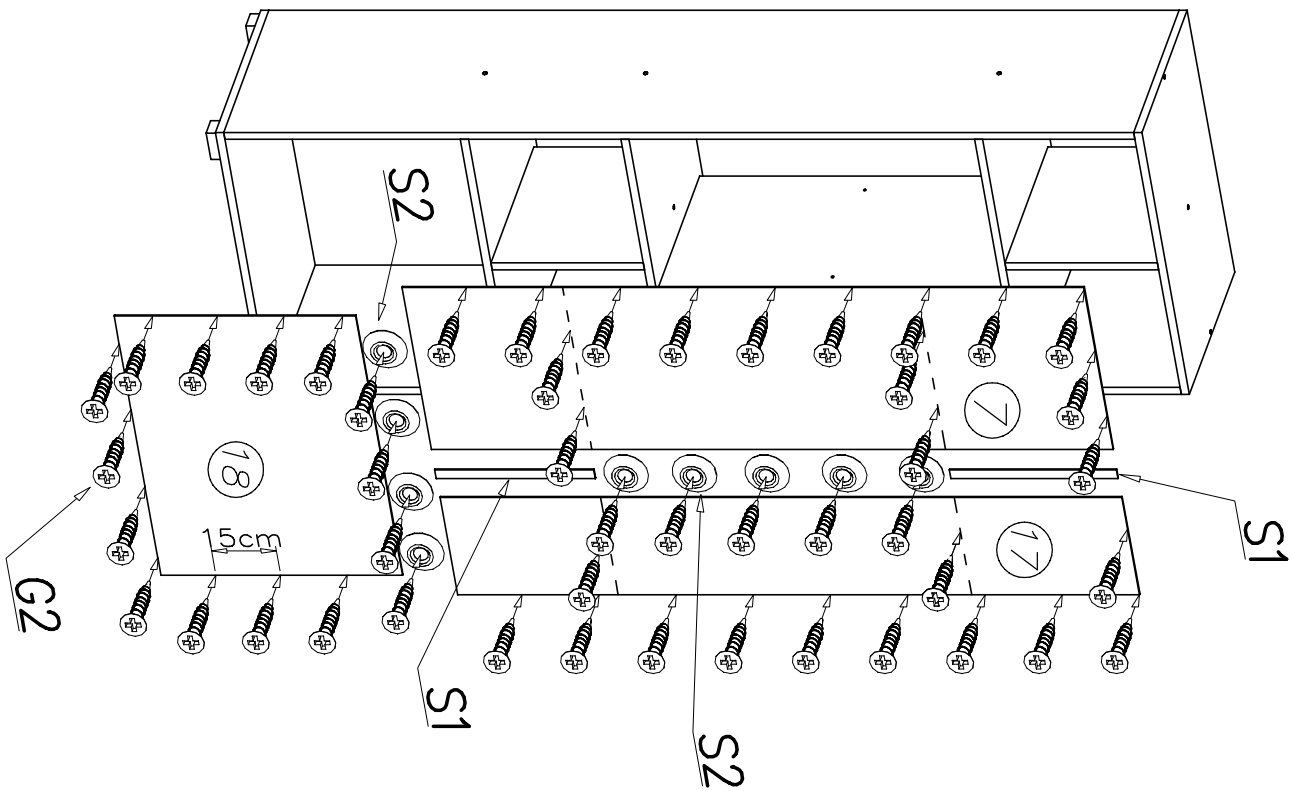

IV

